

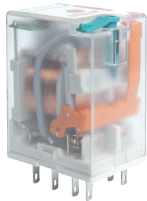



R2N

miniature industrial relays



12 A / 250 V AC



- Relays of general application • For plug-in sockets: 35 mm rail mount acc. to PN-EN 60715; on panel mounting; PCB mounting • Miniature dimensions • Cadmium - free contacts • AC and DC coils
- WT (mechanical indicator + lockable front test button) - standard features of relays. Relays may be provided with the test buttons (no latching) and plugs - page 12
- Recognitions, certifications, directives: RoHS,    

Contact data

Number and type of contacts		2 CO
Contact material		AgNi , AgNi/Au 0,2 µm
Rated / max. switching voltage	AC	250 V / 440 V
Min. switching voltage		10 V
Rated load (capacity)	AC1	12 A / 250 V AC
	AC15	3 A / 120 V 1,5 A / 240 V (B300)
	AC3	370 W (single-phase motor)
	DC1	12 A / 24 V DC (see Fig. 3)
	DC13	0,22 A / 120 V 0,1 A / 250 V (R300)
Min. switching current		5 mA
Max. inrush current		24 A
Rated current		12 A
Max. breaking capacity	AC1	3 000 VA
Min. breaking capacity		0,3 W
Contact resistance		≤ 100 mΩ
Max. operating frequency		
• at rated load	AC1	1 200 cycles/hour
• no load		12 000 cycles/hour

Coil data

Rated voltage	50/60 Hz AC	6 ... 240 V
	DC	5 ... 220 V
Must release voltage		AC: ≥ 0,2 U _n DC: ≥ 0,1 U _n
Operating range of supply voltage		see Tables 1, 2
Rated power consumption	AC	1,6 VA
	DC	0,9 W

Insulation according to PN-EN 60664-1

Insulation rated voltage		250 V AC
Rated surge voltage		4 000 V 1,2 / 50 µs
Overvoltage category		III
Insulation pollution degree		3
Dielectric strength		
• between coil and contacts		2 500 V AC type of insulation: basic
• contact clearance		1 500 V AC type of clearance: micro-disconnection
• pole - pole		2 500 V AC type of insulation: basic
Contact - coil distance		
• clearance		≥ 2,5 mm
• creepage		≥ 4 mm

General data

Operating / release time (typical values)		AC: 10 ms / 8 ms DC: 13 ms / 3 ms
Electrical life		
• resistive AC1		> 10 ⁵ 12 A, 250 V AC
• cosφ		see Fig. 2
Mechanical life (cycles)		> 2 x 10 ⁷
Dimensions (L x W x H)		27,5 x 21,2 x 35,6 mm
Weight		35 g
Ambient temperature	• storage	-40...+85 °C
	• operating	AC: -40...+55 °C DC: -40...+70 °C
Cover protection category		IP 40 PN-EN 60529
Environmental protection		RTI PN-EN 116000-3
Shock resistance	(NO/NC)	10 g / 5 g
Vibration resistance		5 g 10...150 Hz

The data in bold type pertain to the standard versions of the relays.

14.07.2014

Coil data - DC voltage version

Table 1

Coil code	Rated voltage V DC	Coil resistance at 20 °C Ω	Acceptable resistance	Coil operating range V DC	
				min. (at 20 °C)	max. (at 55 °C)
1005	5	28	± 10%	4,0	5,5
1006	6	40	± 10%	4,8	6,6
1012	12	160	± 10%	9,6	13,2
1024	24	640	± 10%	19,2	26,4
1048	48	2 600	± 10%	38,4	52,8
1060	60	4 000	± 10%	48,0	66,0
1080	80	7 100	± 10%	64,0	88,0
1110	110	13 600	± 10%	88,0	121,0
1125	125	16 000	± 10%	100,0	137,5
1220	220	54 000	± 10%	176,0	242,0

The data in bold type pertain to the standard versions of the relays.

Coil data - AC 50/60 Hz voltage version

Table 2

Coil code	Rated voltage V AC	Coil resistance at 20 °C Ω	Acceptable resistance	Coil operating range V AC	
				min. (at 20 °C)	max. (at 55 °C)
5006	6	9,8	± 10%	4,8	6,6
5012	12	39,5	± 10%	9,6	13,2
5024	24	158	± 10%	19,2	26,4
5042	42	470	± 10%	33,6	46,2
5048	48	640	± 10%	38,4	52,8
5060	60	930	± 10%	48,0	66,0
5080	80	1 720	± 10%	64,0	88,0
5110	110	3 450	± 10%	88,0	121,0
5115	115	3 610	± 10%	92,0	127,0
5120	120	3 770	± 10%	96,0	132,0
5127	127	4 000	± 10%	101,6	139,0
5220	220	15 400	± 10%	176,0	242,0
5230	230	16 100	± 10%	184,0	253,0
5240	240	16 800	± 10%	192,0	264,0

The data in bold type pertain to the standard versions of the relays.

NEW TECHNOLOGY

The new R2N, R3N, R4N relays are modernized versions of the R2, R3, R4 relays. The modernization covered the design of the relays and the manufacturing process.



R2N

miniature industrial relays

Dimensions - plug-in version (WT), with lockable front test button type T

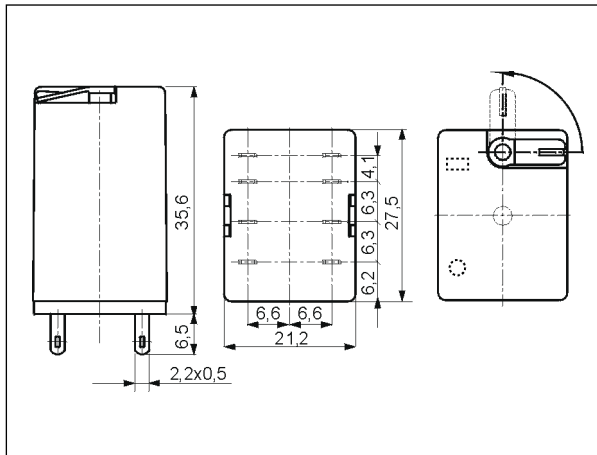

Dimensions - plug-in version, with test button (no latching) or with plug (no manual operation)

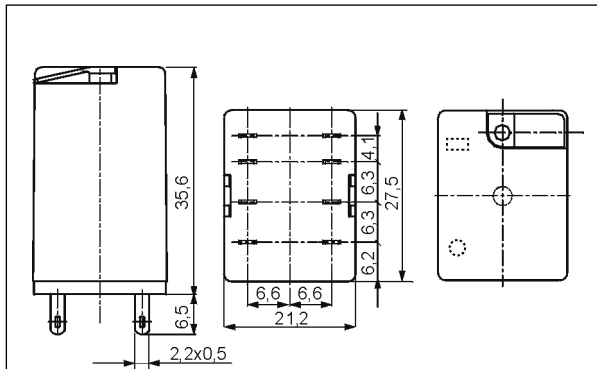

Test buttons R4P-0001 and plugs R4W-0003 need to be ordered separately. They substitute buttons type T. To exchange by Customer themselves. Information on test buttons (no latching) and plugs - page 12.

Connection diagram (pin side view)

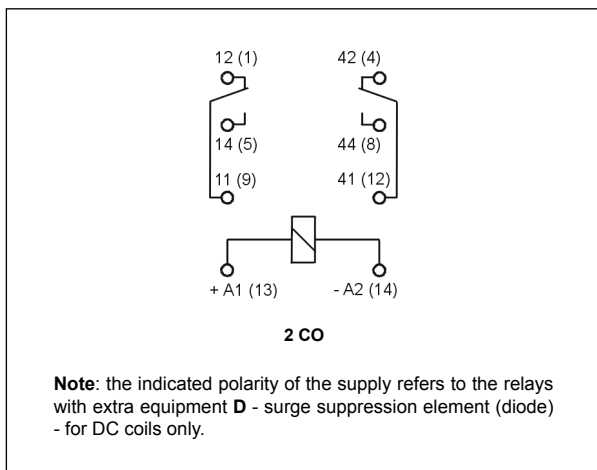

Design

NEW



Improvement of the functionality of the mechanical indicator (W): it is mounted on an insulation base of the unit of the movable contacts; the changes provide the appropriate position in the window in the upper side of the housing irrespectively of the number of operations performed by the relay.

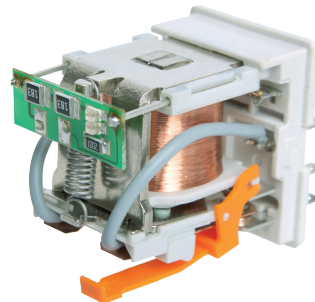

Application of electronics made in the SMD technology: additional features L (LED diode) and D (diode) are located on the printed circuit board; the change of the position of the LED diode and optimization of the quality and intensity of its light provide certainty that the relay is in operation status when the LED is on.

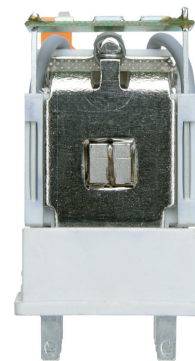

Improvement of the efficiency of the electromagnet: an innovational technology of connecting elements has been introduced, which guarantees more reliable operation of the relay.

Strengthening of the insulation in the area of the contact plate: polyamide PA66 has been applied; it has very good mechanical and electrical parameters and best thermal properties.

Electrical life at AC resistive load. Fig. 1
Switching frequency: 1 200 cycles/hour

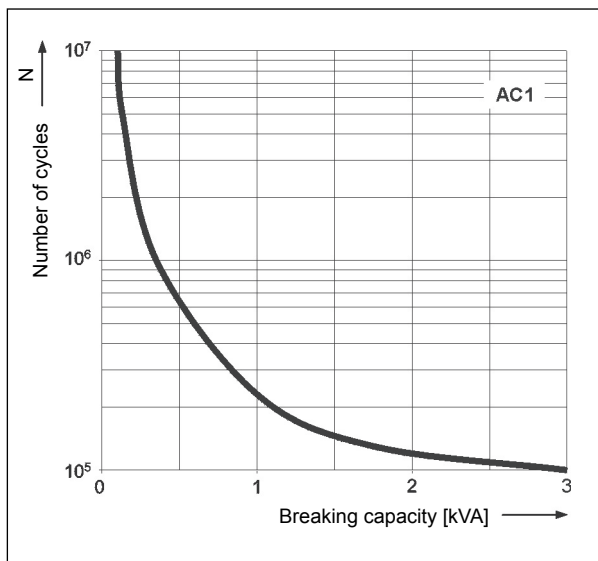

Electrical life reduction factor at AC inductive load Fig. 2

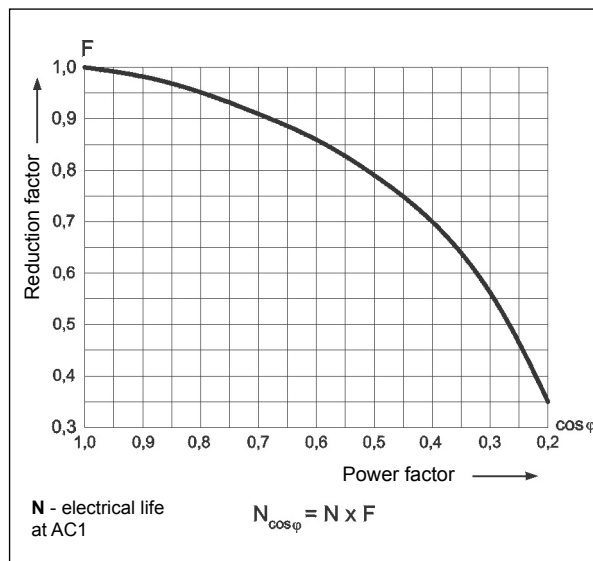

Max. DC resistive load breaking capacity Fig. 3

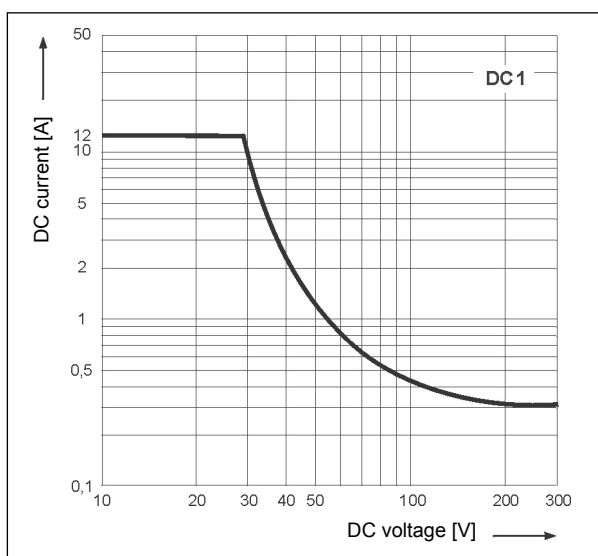

Mounting

Relays **R2N** are offered in versions for plug-in sockets, **with WT features as standard** (W - mechanical indicator + T - lockable front test button). In these relays is **possibility self-exchange of button type T for test button R4P-0001** (no latching) **or on plug R4W-0003** (no manual operation). The buttons **R4P-0001** and the plugs **R4W-0003** **need to ordered separately**.

Relays **R2N** are designed for:

- screw terminals plug-in sockets **GZT2** ① and **GZM2** ① with clip **GZT4-0040** or **G4 1052**, 35 mm rail mount acc. to PN-EN 60715 or on panel mounting with two M3 screws
- spring terminals plug-in sockets **GZMB2** ② with clip **GZMB4-0040** or **G4 1052**, 35 mm rail mount acc. to PN-EN 60715. Signalling / protecting modules **type M...** are available with sockets (see page 9)
- plug-in sockets for PCB mounting **SU4/2D** with clip **G4 1053**
- solder terminals sockets **SU4/2L** with clip **G4 1053** and spring clamp **G4 1040**
- solder terminals sockets **G4/2** with clip **G4 1053**.

Contact material selection for different load types

- **AgNi** - for resistive or inductive loads,
- **AgNi/Au 0,2 μm** - Au protects the contact surface during storage.

① Plug-in sockets **GZT2**, **GZM2** may be linked with interconnection strip type **ZGGZ4** (see page 10).

② For sockets **GZMB2** - see page 6 (wire connection).

Ordering codes

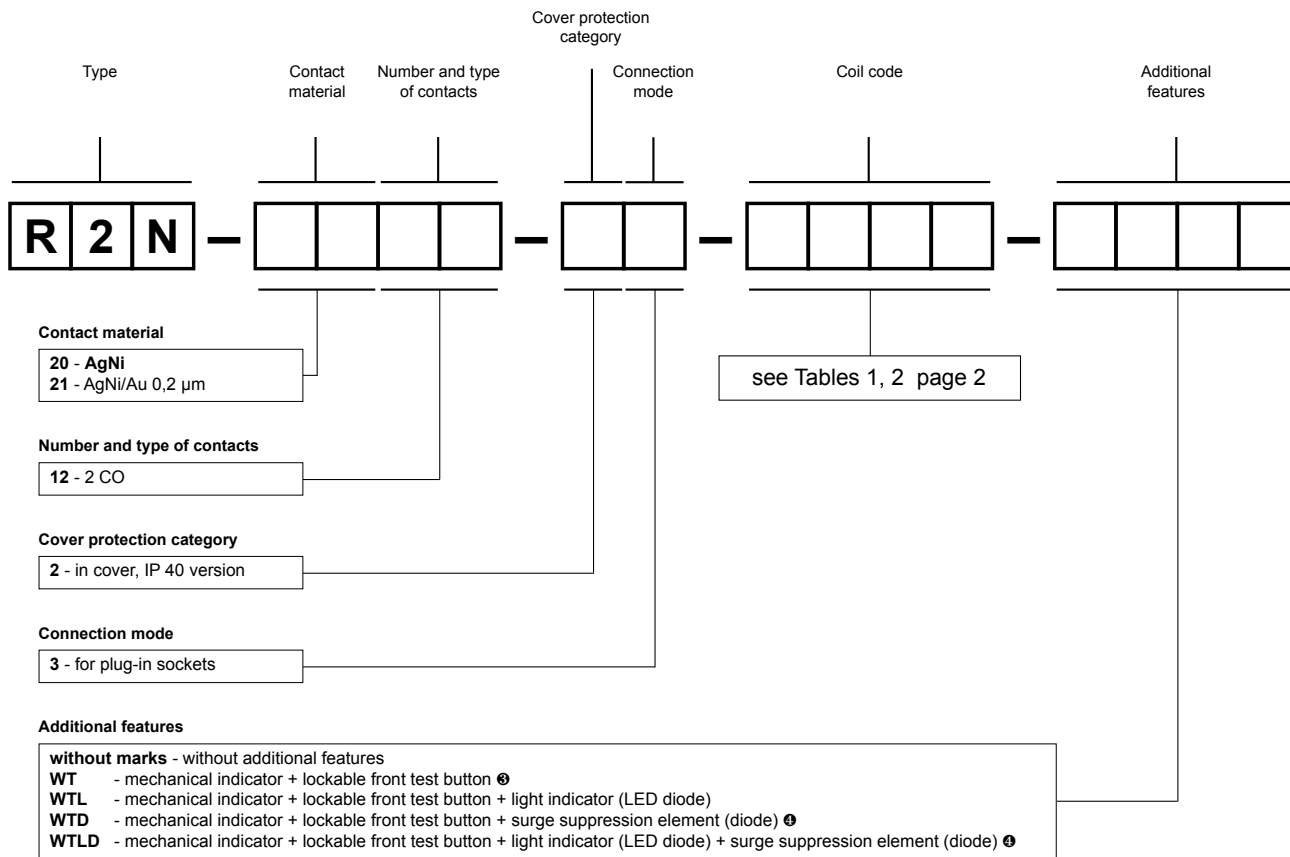

② WT - standard features of relays

④ WTD, WTLD - available only in relays with DC coils

Test buttons (no latching) and plugs need to be ordered separately. They substitute buttons type T. To be exchanged by the customer themselves. Information on test buttons (no latching) and plugs - page 12.

- Button R4P-0001-A - orange colour (AC coils)
- Button R4P-0001-D - green colour (DC coils)
- Plug R4W-0003-A - orange colour (AC coils)
- Plug R4W-0003-D - green colour (DC coils)

Note:

For relays with additional features **D** - surge suppression element (diode) (versions WTD and WTLD) - fixed supply polarity compulsory for the DC load of coils: +A1(13) / -A2(14). The polarity is indicated on the relay cover. For other versions of the relays with DC coils any polarity is possible.

Example of ordering codes:

R2N-2012-23-1024-WT relay R2N, for plug-in sockets, two changeover contacts, contact material AgNi, coil voltage 24 V DC, with mechanical indicator and lockable front test button, in cover IP 40

GZMB2

Plug-in socket with spring terminals for R2N - see page 6



Plug-in sockets and accessories

GZT2

For R2N

Screw terminals
Max. tightening moment for the terminal: 0,7 Nm
35 mm rail mount
acc. to PN-EN 60715
or on panel mounting
76,3 x 27 x 42,5(80) mm 
Two poles
12 A, 300 V AC

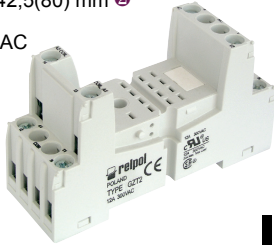

Connection diagram

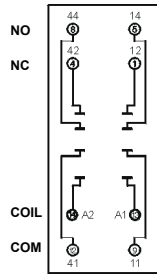

GZT4-0040

G4 1052



Module type M...

Dimensions

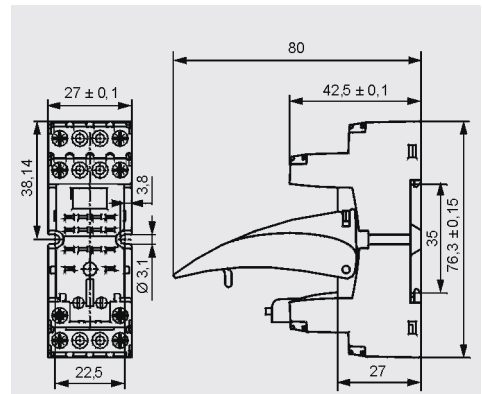

Accessories

GZM2

For R2N

Screw terminals
Max. tightening moment for the terminal: 0,7 Nm
35 mm rail mount
acc. to PN-EN 60715
or on panel mounting
75 x 27 x 61(82) mm 
Two poles
12 A, 300 V AC

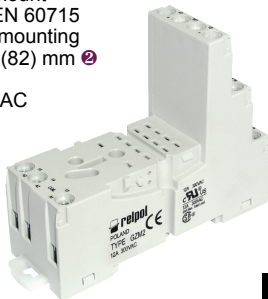

Connection diagram

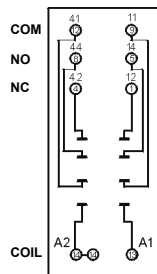

GZT4-0040

G4 1052



Module type M...

Dimensions

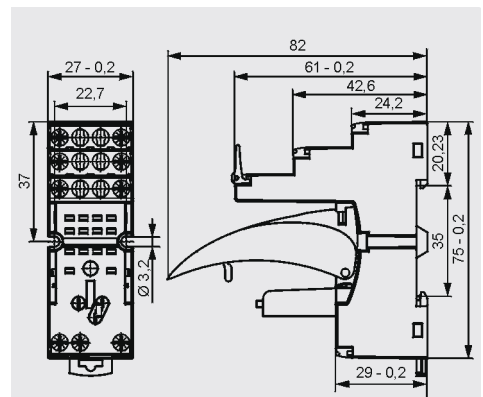

Accessories

GZMB2

For R2N

Spring terminals
Max. cross section of the cables:
1 x 0,2...1,5 mm²
(1 x 24...16 AWG)
Length of the cable deinsulation:
9...11 mm

35 mm rail mount
acc. to PN-EN 60715
95 x 31 x 42,5(80) mm 
Two poles
10 A, 300 V AC



GZMB4-0040



TR



Module type M...



G4 1052

Connection diagram

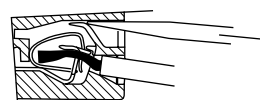
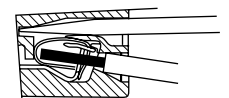
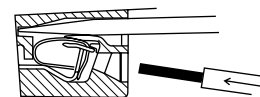
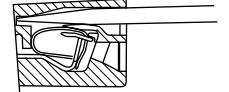
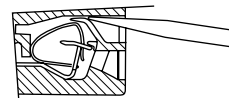
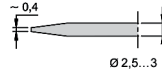
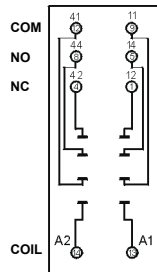

Dimensions

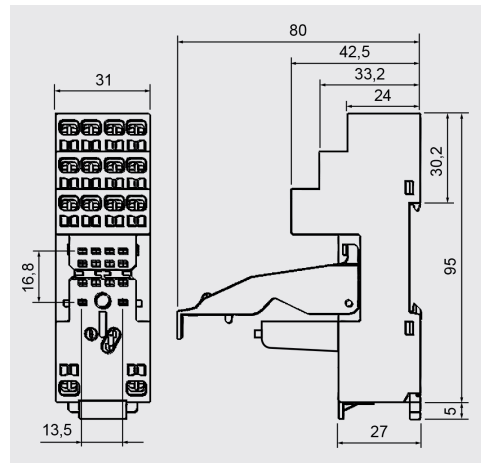

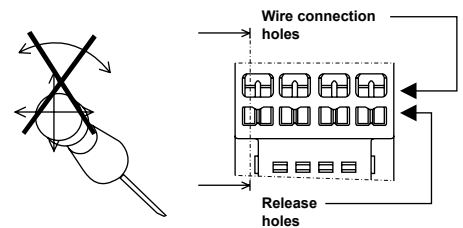

The drawings present the sequence of operations in course of inserting wires to the spring terminal, and the recommended screwdriver to be used for opening of case springs, comply with the DIN 5264 FORM „A“.



Accessories

Wire connection

-  Mounting and sub-assemblies of accessories in the socket - see page 7. Signalling / protecting modules type M... - see page 9.
-  In the bracket the height of socket with retainer / retractor clip is shown.

Mounting and sub-assemblies of the relay and accessories in the socket

Signalling / protecting module
type M...

Electromagnetic
relay

Retainer / retractor clip

Screw terminals
plug-in socket

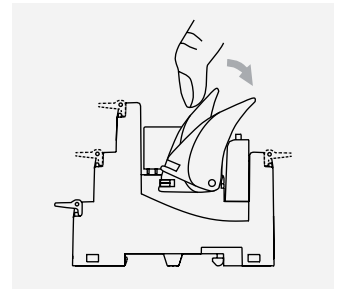

Removing the relay from the socket
with a retractor / retractor clip

Description plate

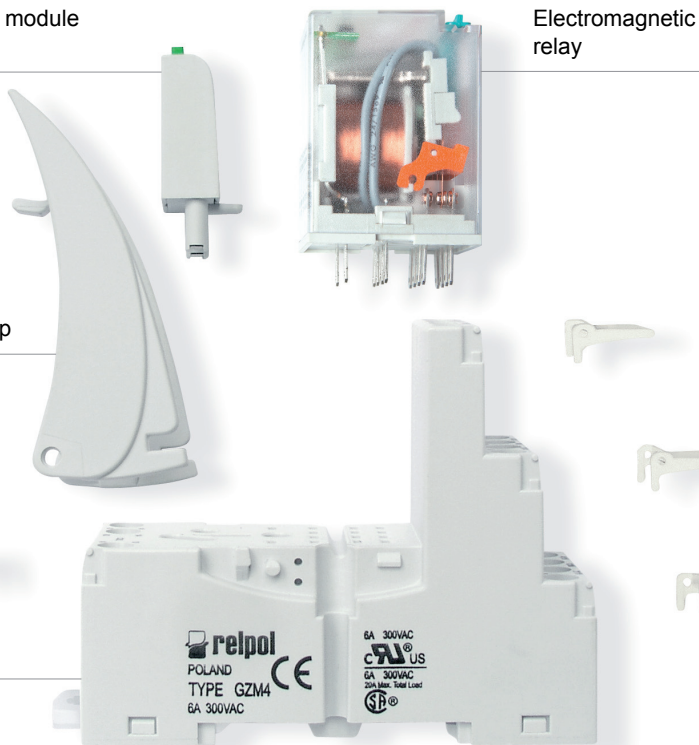

PRECAUTIONS:

1. Ensure that the parameters of the product described in its specification provide a safety margin for the appropriate operation of the device or system and never use the product in circumstances which exceed the parameters of the product. 2. Never touch any live parts of the device. 3. Ensure that the product has been connected correctly. An incorrect connection may cause malfunction, excessive heating or risk of fire. 4. In case of any risk of any serious material loss or death or injuries of humans or animals, the devices or systems shall be designed so to equip them with double safety system to guarantee their reliable operation.

Plug-in sockets and accessories

SU4/2D

For R2N
For PCB
29,6 x 21,5 x 11 mm
Two poles
12 A, 250 V AC

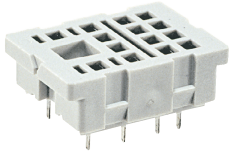

Pinout

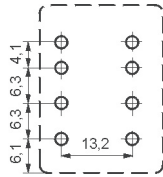

Accessories

G4 1053

Dimensions

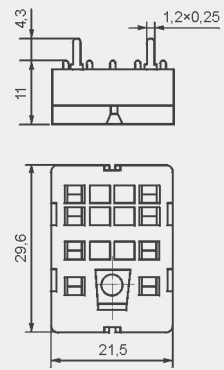

SU4/2L

For R2N
Solder terminals
29,6 x 21,5 x 18,1 mm
Two poles
12 A, 250 V AC

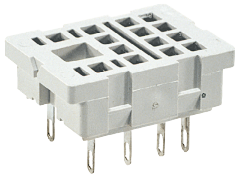

Dimensions of opening on panel mounting

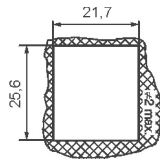

Accessories

G4 1053

G4 1040

Dimensions

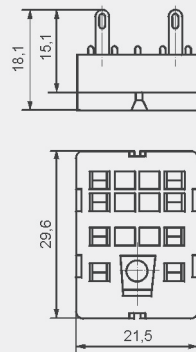

G4/2

For R2N
Solder terminals
40,5 x 21,5 x 18,1 mm
Two poles
12 A, 250 V AC

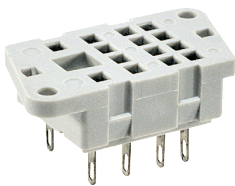

Pinout of openings on panel mounting

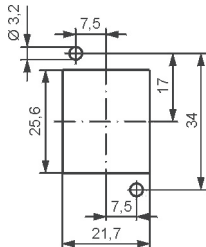

Accessories

G4 1053

Dimensions

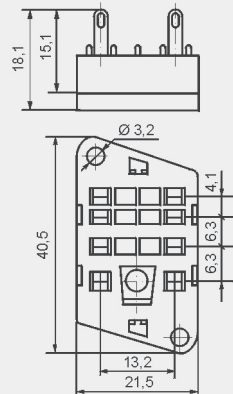

Signalling / protecting modules type M...

For sockets type:

GZT80, GZM80, GZS80, GZMB80, GZT92, GZM92, GZS92, ES 32, GZT2, GZM2, GZMB2, GZT3, GZM3, GZT4, GZM4, GZMB4

Modules type M... are parallelly connected with relay coil.

Polarity P: -A1/+A2. Polarity N: +A1/-A2.

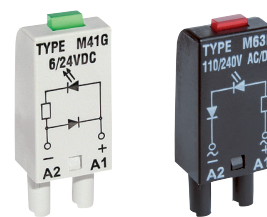

Modules type M...	Layout	Voltage	Type of module ① ②
Module D (polarization P) It limits overvoltage on DC coils.		6/230 V DC	M21P
Module D (polarization N) It limits overvoltage on DC coils.		6/230 V DC	M21N
Module LD (polarization P) It limits overvoltage on DC coils. Coil energizing indication.		6/24 V DC 24/60 V DC 110/230 V DC	M31R, M31G M32R, M32G M33R, M33G
Module LD (polarization N) It limits overvoltage on DC coils. Coil energizing indication.		6/24 V DC 24/60 V DC 110/230 V DC	M41R, M41G M42R, M42G M43R, M43G
Module RC It protects against EMC disturbance. It limits overvoltage.		6/24 V AC 24/60 V AC 110/240 V AC	M51 M52 M53
Module L Coil energizing indication.		6/24 V AC/DC 24/60 V AC/DC 110/230 V AC/DC	M61R, M61G M62R, M62G M63R, M63G
Module LV It limits overvoltage on AC and DC coils. Coil energizing indication.		6/24 V AC/DC 24/60 V AC/DC 110/230 V AC/DC	M91R, M91G M92R, M92G M93R, M93G
Module V It limits overvoltage on AC and DC coils. No indication.		24 V AC 130 V AC 230 V AC	M71 M72 M73
Module R It limits overvoltage on AC coils.		110/230 V AC	M103

① M...R - LED red, M...G - LED green

② When ordering modules indicate their color: gray or black.

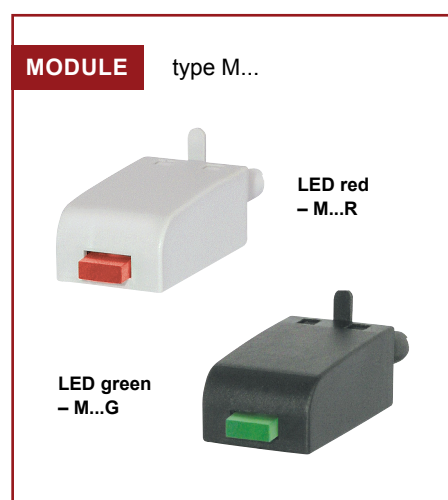

Interconnection strips ZGGZ4



PIR2-...-00L.
(R2N + GZM2)

ZGGZ4

ZGGZ4 for:

Plug-in sockets	Relays for plug-in sockets	Interface relays ^⑥
GZT2	R2N	PIR2-...-00L. (R2N + GZM2)
GZM2		PIR3-...-00L. (R3N + GZM3)
GZT3	R3N	PIR4-...-00L. (R4N + GZM4)
GZM3		
GZT4	R4N	
GZM4		



^⑥ Interface relay **PIR2 (PIR3, PIR4)** is offered as a **set**: plug-in socket **GZM2 (GZM3, GZM4)** + miniature industrial relay **R2N (R3N, R4N)** + signalling / protecting module **type M...** + retainer / retractor clip **GZT4-0040** + description plate **GZT4-0035**.



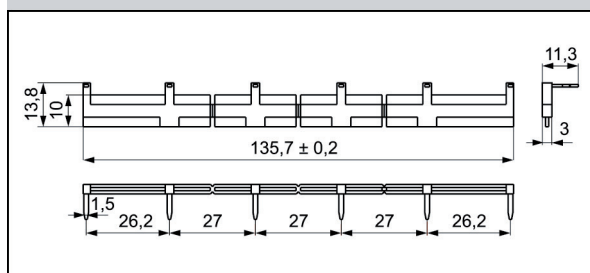
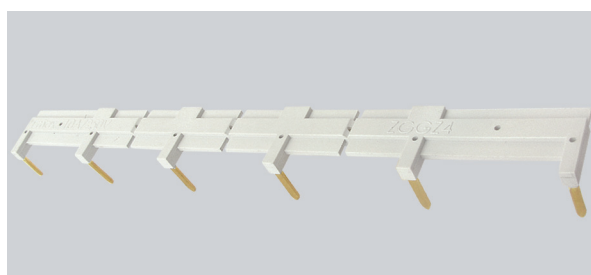



Interconnection strip ZGGZ4

- designed for the co-operation with plug-in sockets of miniature industrial relays and with interface relays PIR2, PIR3 and PIR4, which are equipped with screw terminals; sockets and relays are mounted on 35 mm rail mount acc. to PN-EN 60715,
- bridges common input signals (coil terminals A1 or A2) or output signals - see photo at the top,
- maximum permissible current is 10 A / 250 V AC,
- possibility of connection of 6 sockets or relays,
- colours of strips: **ZGGZ4-1** grey, **ZGGZ4-2** black.



Additional features for industrial relays

Industrial relays for plug-in sockets: R2N, R3N, R4N, R15 - 2 CO , R15 - 3 CO  with **WT features as standard** (**W** - mechanical indicator + **T** - lockable front test button). **Detailed information** on additional features of individual relays can be found in the data sheets on the side of "Ordering codes".

Type 	Description	For industrial relays
W	mechanical indicator	R2N, R3N, R4N, (R15 - 2 CO, 3 CO )
T	lockable front test button, orange colour - AC coils, green colour - DC coils	R2N, R3N, R4N, (R15 - 2 CO, 3 CO )
L	light indicator (LED diode), located inside the relay	R2N, R3N, R4N, RY2, (R15 - 2 CO, 3 CO, 4 CO ) RUC, RUC-M
D	surge suppression element (diode) - only for DC coils	R2N, R3N, R4N, RY2, (R15 - 2 CO, 3 CO, 4 CO )
V	surge suppression element (varistor) - only for AC coils	(R15 - 2 CO, 3 CO )
K	test button without block function	(R15 - 4 CO ), RUC

 Available combinations:

WT, WTL, WTD, WTL D - in relays R2N, R3N, R4N for plug-in sockets

L, D, LD - in relays RY2 for plug-in sockets

WT, WTL, WTD, WTL D, WTV, WTL V - in relays R15 - 2 CO, 3 CO for plug-in sockets

K, L, D, KL, KD, LD, KLD - in relays R15 - 4 CO for plug-in sockets

K, L, KL - in relays RUC

L - in relays RUC-M

 Voltage versions, in covers

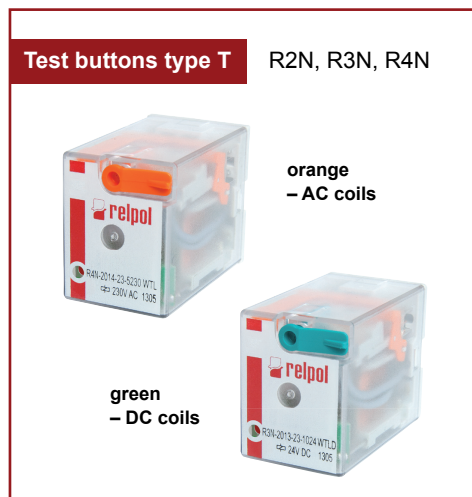

Test buttons (no latching) and plugs

Test buttons (no latching) are recommended for R2N...WT, R3N...WT, R4N...WT, R15...WT 2 CO, R15...WT 3 CO relays - **for applications that do not allow permanent contact latching**. By manual operation (pressing the button) relay contacts can get switched for as long time as long the button is pressed. Contacts return to initial position as soon as pressure is released from the button. Those operations can be done while the coil is deenergized.

Button **R4P-0001** or **R15-M404** can be easily inserted by the Customer after removal of button type **T** (see Fig. 2). Button type **T** can be removed with screwdriver as shown on Fig. 1.

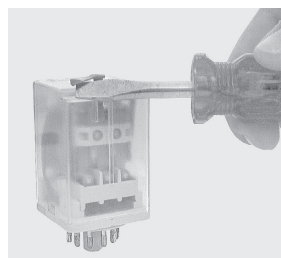

Fig. 1

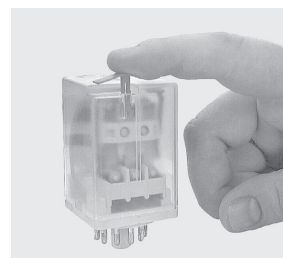
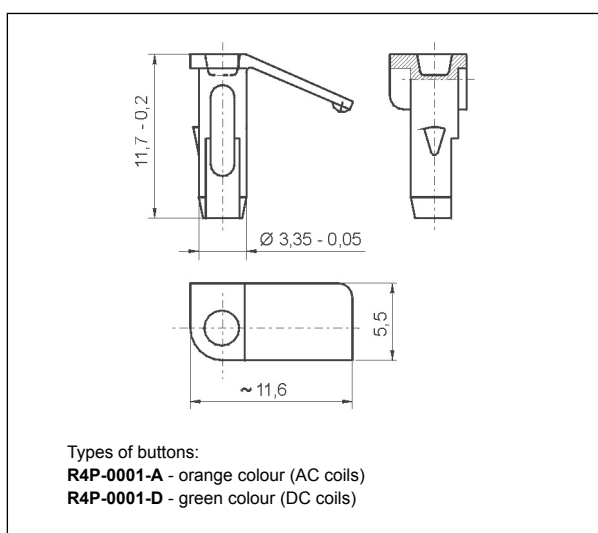
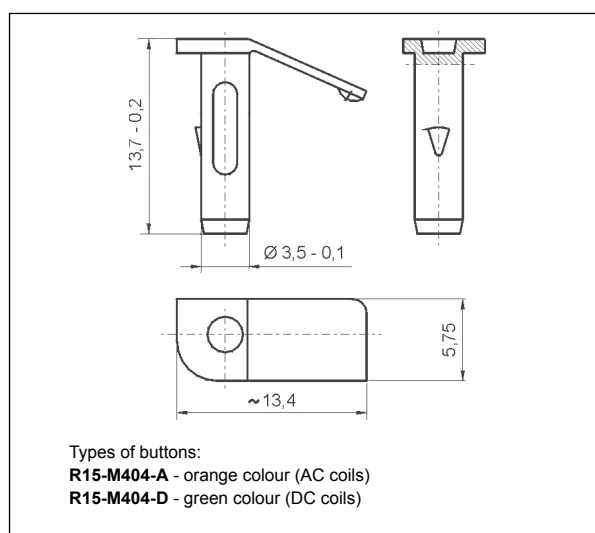

Fig. 2

Dimensions - test button R4P-0001 for R2N...WT, R3N...WT, R4N...WT



Dimensions - test button R15-M404 for R15...WT 2 CO, R15...WT 3 CO



Plugs R4W-0003 or **R15-M203** can substitute button type **T** if **manual operation (latching and testing) is not allowed**. Changing button type **T** for plug can be done by Customer themselves in the same way as changing button type **T** for button (no latching).

Dimensions - plug R4W-0003 for R2N...WT, R3N...WT, R4N...WT

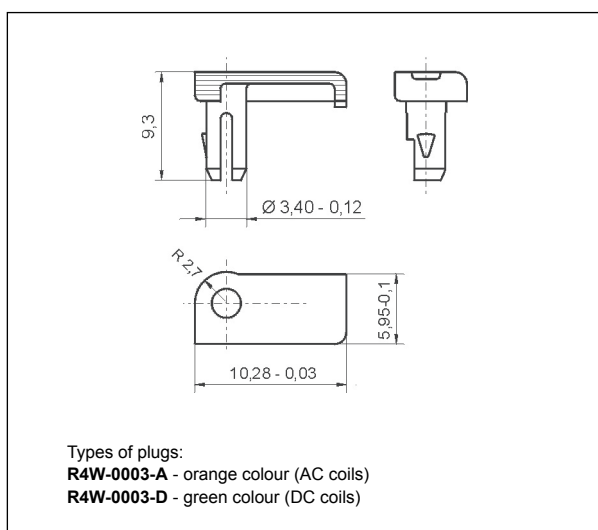

Dimensions - plug R15-M203 for R15...WT 2 CO, R15...WT 3 CO

