

PIR15...T with time module COM3

time relays



R15 - 3 CO
+ GZP11
+ COM3

R15 - 2 CO
+ GZP8
+ COM3

- Time relay **PIR15 - 3 CO (standard)** consists of: electromagnetic relay **R15 - 3 CO**, black plug-in socket **GZP11**, time module **COM3**, spring wire clip **GZP-0054**, white description plate **GZP-0035**
- Time relay **PIR15 - 2 CO** consists of: electromagnetic relay **R15 - 2 CO**, black plug-in socket **GZP8**, time module **COM3**, spring wire clip **GZP-0054**, white description plate **GZP-0035**
- 35 mm rail mount acc. to EN 60715 or on panel mounting with two M3 screws
- Recognitions, certifications, directives: recognitions R15, RoHS,



Output circuits - contact data

Number and type of contacts	2 CO, 3 CO	
Contact material	AgNi	
Max. switching voltage	440 V AC / 250 V DC	
Rated load (capacity)	AC1	10 A / 250 V AC 10 A / 277 V AC UL 508
	AC15	3 A / 120 V 1,5 A / 240 V (B300)
	DC1	10 A / 24 V DC (see Fig. 3)
	DC13	0,22 A / 120 V 0,1 A / 250 V (R300)
Motor load	acc. to UL 508	1/2 HP 240 V AC, 4,9 FLA, single-phase motor ❶
	AC3 acc. to IEC 60947-4-1	0,37 kW 240 V AC, single-phase motor
Max. inrush current	20 A	
Rated current	10 A	
Max. breaking capacity	AC1	2 500 VA
Min. breaking capacity	0,3 W 5 V, 5 mA	
Contact resistance	≤ 100 mΩ	
Max. operating frequency	• at rated load AC1	1 200 cycles/hour
	• no load	12 000 cycles/hour
Input circuit		
Rated voltage of output relay R15	50/60 Hz AC	24, 48, 60, 110, 120, 230, 240 V
	DC	24, 48, 60, 110, 120, 220 V
Supply voltage of time module COM3	24...240 V AC/DC (universal module)	
Operating range of supply voltage	0,85...1,1 U _n see Tables 1, 2	
Rated power consumption	AC	3,0 VA
	DC	2,0 W
Range of supply frequency	48...63 Hz	
Control contact S ❷		
• connections	not potential free, terminals A1-B1	
• line length	max. 10 m (twisted pair)	
• min. time of pulse duration ❸	100 ms	
Insulation according to EN 60664-1		
Insulation rated voltage	250 V AC	
Overvoltage category	III	
Dielectric strength	• input - outputs	2 500 V AC type of insulation: basic
	• contact clearance	1 500 V AC type of clearance: micro-disconnection
	• pole - pole	2 000 V AC type of insulation: basic
	Input - outputs distance	• clearance
	• creepage	≥ 4,2 mm
General data		
Operating / release time (typical values)	AC: 12 ms / 10 ms	DC: 18 ms / 7 ms
Electrical life	• resistive AC1	> 2 x 10 ⁵ 10 A, 250 V AC
	• cosφ	see Fig. 2
Mechanical life (cycles)	> 2 x 10 ⁷	
Dimensions (L x W x H)	73 x 38,2 x 85,4 mm	
Weight	3 CO: 175 g	2 CO: 168 g
Ambient temperature	• storage	-40...+70 °C
	(non-condensation and/or icing) • operating	-40...+55 °C
Cover protection category	IP 20	EN 60529
Environmental protection	R15: RTI GZP11, GZP8: RT0	EN 61810-7
Shock resistance	10 g	
Vibration resistance	5 g 10...500 Hz	

The data in bold type relate to the standard versions of the relays. ❶ For single phase motors for 110-120 V AC do not use motors with higher FLA than given for 240 V AC. ❷ The control terminal B1 is activated by connection to A1 terminal via the external control contact S. ❸ Where the control signal is recognizable.

PIR15...T with time module COM3

time relays

Time module data

Functions	E, Wu, Bp, Bi, R, Ws, Wa, Es
Function adjustment ④	selection with microswitches
Time ranges	1 s; 10 s; 1 min.; 10 min.; 1 h; 10 h; 1 d; 10 d
Timing adjustment ④	time range - with microswitches smooth - (0,05...1) x time range - with potentiometer
Base accuracy	± 1% (calculated from the final range values)
Setting accuracy	± 5% (calculated from the final range values)
Repeatability	± 0,5% or ± 5 ms
Temperature influence	± 0,01% / °C
Recovery time	150 ms
LED indicator	green LED U ON - indication of supply voltage U green LED U flashing - measurement of T time

④ Settings of switches - see below.

Settings of switches

Function adjustment	E	Wu	Bi	Bp	R	Ws	Wa	Es
microswitches 1, 2, 3								
Timing adjustment (max.) microswitches 4, 5, 6								

Connection diagrams (screw terminals side view)

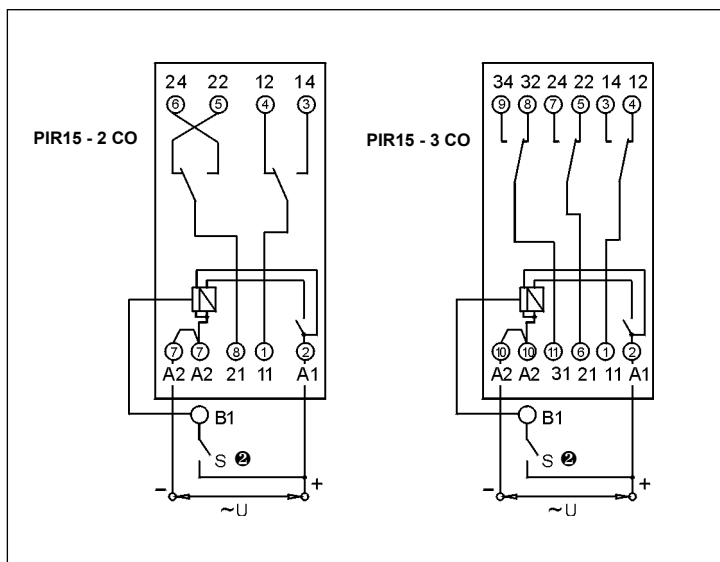

② The control terminal B1 is activated by connection to A1 terminal via the external control contact S.

Dimensions - time module COM3

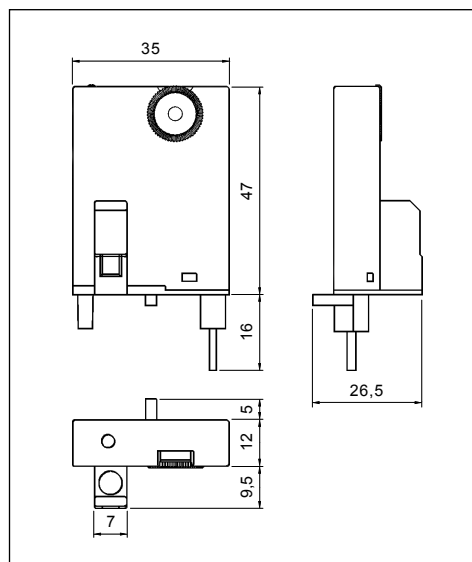

PRECAUTIONS:

1. Ensure that the parameters of the product described in its specification provide a safety margin for the appropriate operation of the device or system and never use the product in circumstances which exceed the parameters of the product. 2. Never touch any live parts of the device. 3. Ensure that the product has been connected correctly. An incorrect connection may cause malfunction, excessive heating or risk of fire. 4. In case of any risk of any serious material loss or death or injuries of humans or animals, the devices or systems shall be designed so to equip them with double safety system to guarantee their reliable operation.

COM3

Universal time module - see www.repol.com.pl

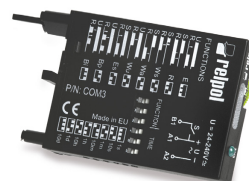

Time functions

E - ON delay.

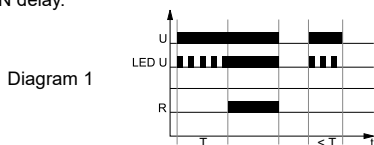

When the supply voltage U is applied, the set interval T begins (green LED flashing). After the interval T has expired (green LED illuminated) the output relay R switches into on-position. This status remains until the supply voltage is interrupted - see Diagram 1.

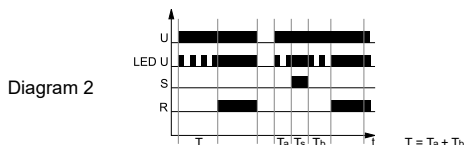

Additional option (ON delay adding): if the control contact S is closed the running interval T is stopped (green LED illuminated) and the interval already expired is saved. When the control contact S is opened once again the interval T is continued (green LED flashing). After the interval T has expired, the control contact S can be operated as you like - see Diagram 2.

Wu - Single shot leading edge voltage controlled.

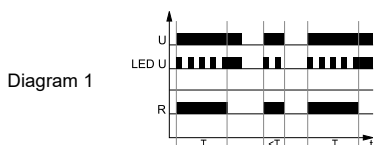

When the supply voltage U is applied, the output relay R switches into on-position and the set interval T begins (green LED flashing). After the interval T has expired (green LED illuminated) the output relay switches into off-position. This status remains until the supply voltage is interrupted. If the supply voltage is interrupted before the interval T has expired, the output relay switches into off-position. The interval already expired is erased and is restarted when the supply voltage is next applied - see Diagram 1.

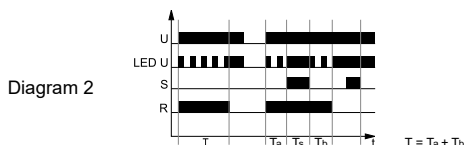

Additional option (Single shot leading edge adding): if the control contact S is closed the running interval T is stopped (green LED illuminated) and the interval already expired is saved. When the control contact S is opened once again the interval T is continued (green LED flashing). After the interval T has expired, the control contact S can be operated as you like - see Diagram 2.

Bp - Symmetrical cyclical operation pause first.

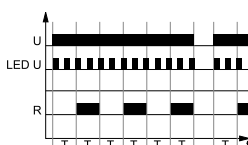

Applying the supply voltage U starts the cyclical operation from the interval T - switching the output relay R off followed by switching on the output relay R for the interval T. The cyclical operation lasts until the supply voltage U is interrupted.

Bi - Symmetrical cyclical operation pulse first.

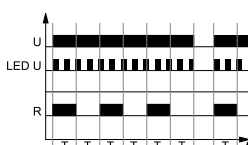

Applying the supply voltage U starts the cyclical operation from switching on the output relay R for the set interval T. After the interval T has lapsed, the output relay R switches off for the interval T. The cyclical operation lasts until the supply voltage U is interrupted.

R - OFF delay with the control contact S.

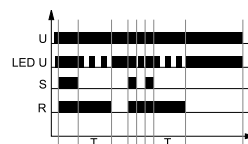

The input of the time relay is supplied with voltage U continuously. Closing of the control contact S immediately switches on the output relay R. Opening of the control contact S starts the set time of the delayed switching off of the output relay R. After the interval T has lapsed, the output relay R switches off. If the control contact S is closed during the interval T, the already measured time is reset, and the output relay R is switched on again. The OFF delay of the output relay R will start when the control contact S is opened again.

Ws - Single shot for the set interval triggered by closing of the control contact S.

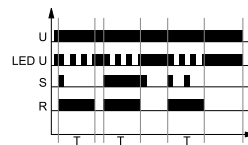

The input of the time relay is supplied with voltage U continuously. Closing of the control contact S immediately switches the output relay R on for the set interval T. After the interval T has lapsed, the output relay R is switched off. In the course of the interval T, any opening of the control contact S does not affect the function to be performed. The output relay R may be switched on again for the set interval, after the interval T has lapsed, by closing the control contact S again.

Wa - ON for the set interval triggered with the control contact S.

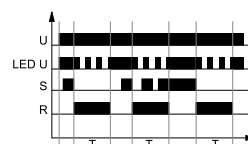

The input of the time relay is supplied with voltage U continuously. Closing of the control contact S does not start the interval T, and it does not change the position of the output relay R. Opening of the control contact S immediately switches on the output relay R for the set time. After the interval T has lapsed, the output relay R switches off. Opening and closing of the control contact S in the course of the interval T does not affect the function to be performed. The output relay R may be switched on again for the set interval with another closing and opening of the control contact S.

Es - ON delay with the control contact S.

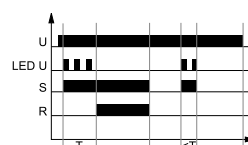

The input of the time relay is supplied with voltage U continuously. Closing of the control contact S starts the interval T - on-delay of the output relay R. After the interval T has lapsed, the output relay R switches on and remains in this position until the control contact S is opened. In case the control contact S is closed for time shorter than the set interval T, the output relay R will not activate.

U - supply voltage; R - output state of the relay; S - control contact state; T - measured time; Ta, Tb - component intervals of T time; Ts - period of T time interrupt; t - time axis

PIR15...T with time module COM3 time relays

Dimensions

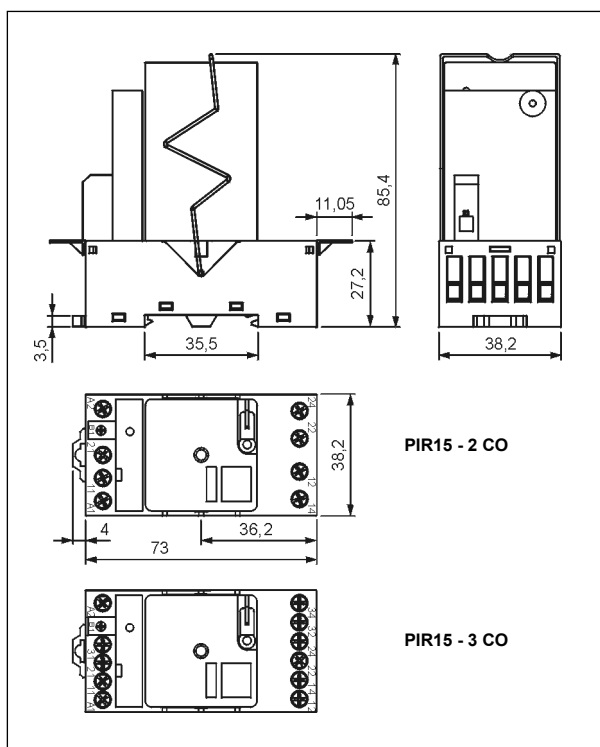

Electrical life at AC resistive load. Switching frequency: 1 200 cycles/hour

Fig. 1

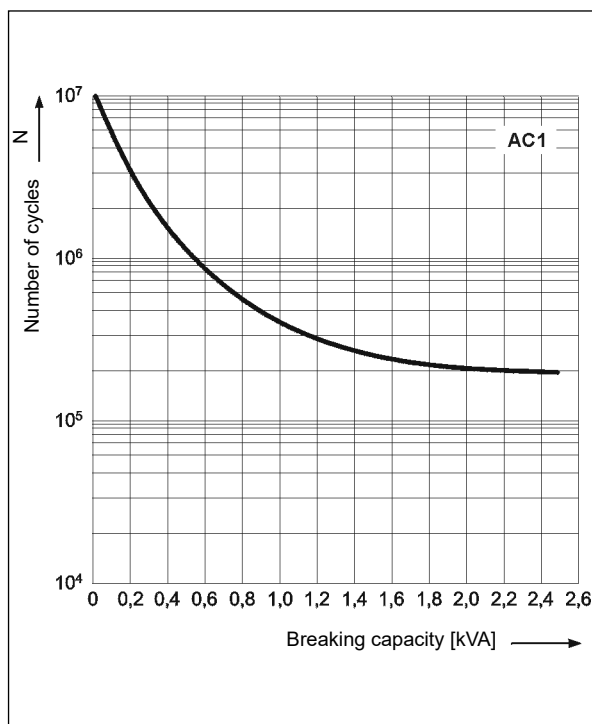

Electrical life reduction factor at AC inductive load

Fig. 2

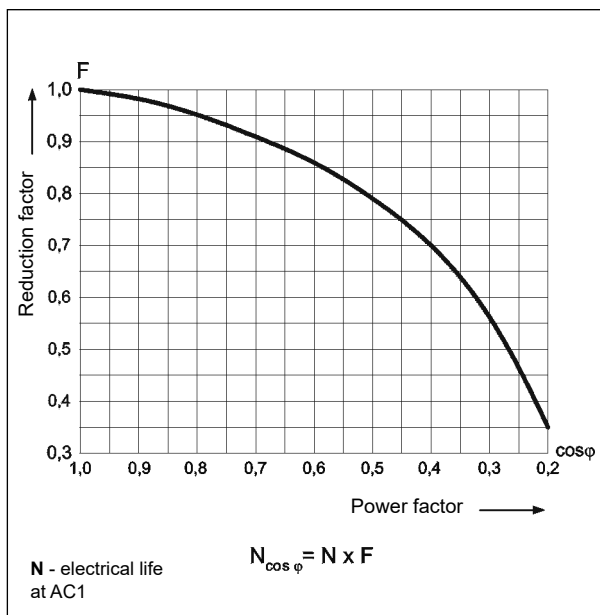

Max. DC breaking capacity A - resistive load DC1 B - inductive load L/R = 40 ms

Fig. 3

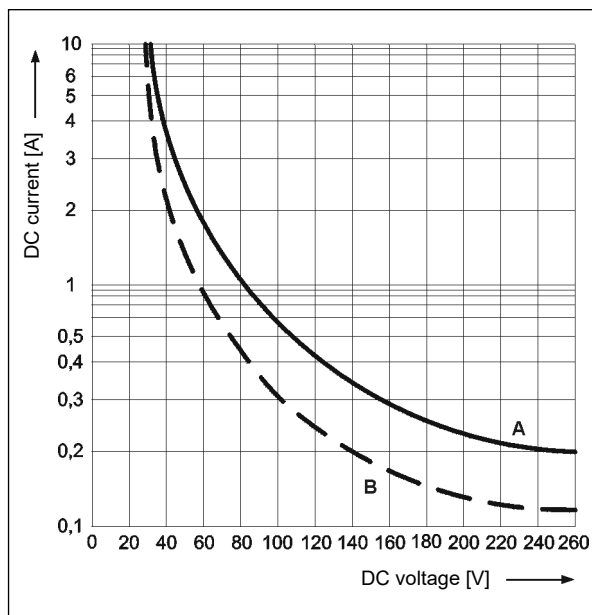

Mounting

Relays PIR15...T are designed for direct mounting on 35 mm rail mount acc. to EN 60715 or on panel mounting with two M3 screws. **Connections:** max. cross section of the cables (stranded): $2 \times 2,5 \text{ mm}^2$ ($2 \times 14 \text{ AWG}$), stripping length: 6,5 mm, max. tightening moment for the terminal: 0,5 Nm.

PIR15...T with time module COM3

time relays

Input data - DC voltage version

Table 1

Input voltage code	Rated input voltage U_n V DC	Input resistance at 20 °C Ω	Acceptable resistance	Input - voltage range V DC	
				min. (at 20 °C)	max. (at 55 °C)
024DC	24	430	± 10%	19,2	26,4
048DC	48	1 750	± 10%	38,4	52,8
060DC	60	2 700	± 10%	48,0	66,0
110DC	110	9 200	± 10%	88,0	121,0
120DC	120	11 000	± 10%	96,0	132,0
220DC	220	37 000	± 10%	176,0	242,0

The data in bold type relate to the standard versions of the relays.

Input data - AC 50/60 Hz voltage version

Table 2

Input voltage code	Rated input voltage U_n V AC	Input resistance at 20 °C Ω	Acceptable resistance	Input - voltage range V AC	
				min. (at 20 °C)	max. (at 55 °C)
024AC	24	75	± 15%	19,2	26,4
048AC	48	305	± 15%	38,4	52,8
060AC	60	475	± 15%	48,0	66,0
110AC	110	1 700	± 15%	88,0	121,0
120AC	120	1 910	± 15%	96,0	132,0
230AC	230	7 080	± 15%	184,0	253,0
240AC	240	7 760	± 15%	192,0	264,0

The data in bold type relate to the standard versions of the relays.

Ordering codes

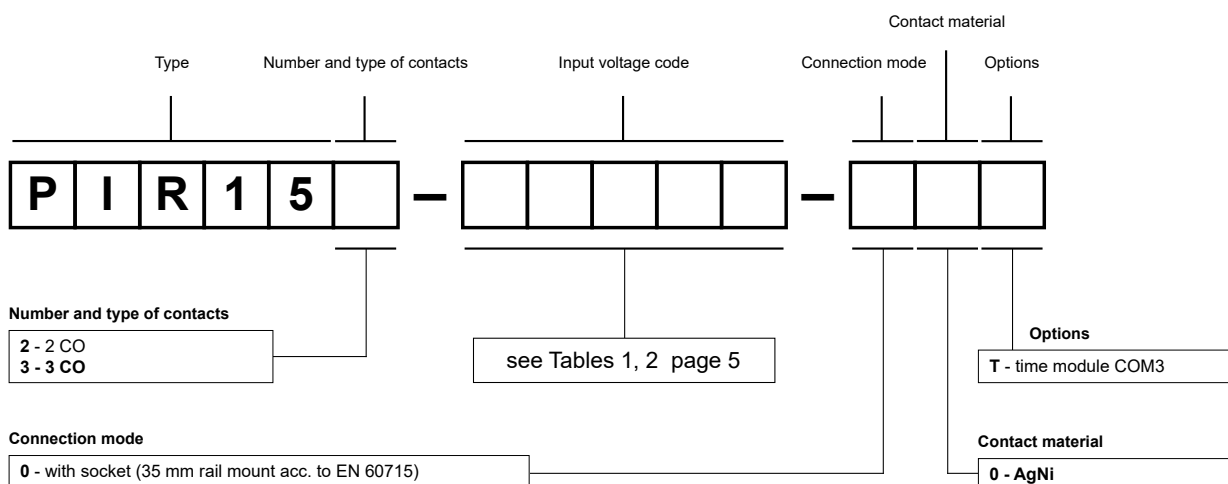

Examples of ordering codes:

PIR153-230AC-00T

time relay **PIR15 - 3 CO** consists of: relay **R15 - 3 CO** (three changeover contacts, contact material AgNi, input voltage 230 V AC 50/60 Hz), socket **GZP11** (black, screw terminals), time module **COM3**, spring wire clip **GZP-0054**, description plate **GZP-0035** (white)

PIR152-024DC-00T

time relay **PIR15 - 2 CO** consists of: relay **R15 - 2 CO** (two changeover contacts, contact material AgNi, input voltage 24 V DC), socket **GZP8** (black, screw terminals), time module **COM3**, spring wire clip **GZP-0054**, description plate **GZP-0035** (white)